

## **INFLUENCE OF THE SHORT TIME GRINDING ON THE THERMAL DECOMPOSITION PROCESSES OF GIBBSITE PRODUCED BY THE BAYER PROCESS**

VIKTOR ZSOLT BARANYAI<sup>1</sup>–FERENC KRISTÁLY<sup>2</sup>–ISTVÁN SZÚCS<sup>3</sup>

The thermal decomposition of aluminum hydroxides follows two courses depending on the circumstances of the heat treatment (temperature, heating rate, pressure, etc.) and the properties of the particles (particle size, shape etc.). The conversion of aluminum hydroxides to aluminum oxides can occur via monohydroxide boehmite [ $\gamma$  – AlO(OH)], or directly to oxides. In practice both courses exist, with the dominant decomposition of hydroxides directly to oxides.

We reduced the particle size of gibbsite [ $\gamma$  – Al(OH)<sub>3</sub>] produced by the Bayer process, by grinding to reduce the thermal decomposition via boehmite. Our aim was to avoid the conversion of the mineral composition of the aluminum hydroxides during the grinding. We examined the particle size, mineral composition via X-ray diffraction (XRD), and the thermal decomposition processes via thermogravimetry (TG) and differential thermal analysis (DTA) of the samples.

**Keywords:** gibbsite, thermal decomposition, grinding.

### **Introduction**

The end-product of the Bayer cycle, the gibbsite [ $\gamma$  – Al(OH)<sub>3</sub>] is calcined (thermally treated) to alumina (aluminum oxide). During the calcination the wet gibbsite loses first its adhesive moisture than the bonded water (34% referring to the dry hydrate material) exits. The only thermodynamically stable oxide phase is the corundum ( $\alpha$ -Al<sub>2</sub>O<sub>3</sub>). All of decomposition pathways are closed by the formation of corundum [1].

The pathway and degree of the decomposition of the aluminum-hydroxides are influenced by many factors, these are: the physicochemical properties of the initial raw (untreated) material (particle size, shape, substituting elements etc.) and the circumstances of the heat treatment (temperature, heating rate, composition of the atmosphere, pressure etc.) [2].

Several researchers investigated profoundly the processes of the calcination of aluminum-hydroxides. 0 schematically summarizes the pathways of gibbsite thermal decomposition. The following mechanisms are proposed in normal atmospheric air

---

<sup>1</sup> University of Miskolc, Department of Combustion Technology and Thermal Energy  
3515 Miskolc-Egyetemváros, Hungary  
tuzbvzs@uni-miskolc.hu

<sup>2</sup> University of Miskolc, Department of Mineralogy and Petrology  
3515 Miskolc-Egyetemváros, Hungary  
askkf@uni-miskolc.hu

<sup>3</sup> University of Miskolc, Department of Combustion Technology and Thermal Energy  
3515 Miskolc-Egyetemváros, Hungary  
tuzsi@uni-miskolc.hu

pressure. Gibbsite decomposes to oxide above the temperature of 300 °C. Increasing the temperature different transition alumina phases appear, further between 1150–1200 °C corundum evolves. Over 200 °C gibbsite loses two moles water transformed into oxihydroxide boehmite. Boehmite decomposes into transitional alumina at 500 °C. The last step of the pathway is the formation of corundum at 1050–1100 °C [1].

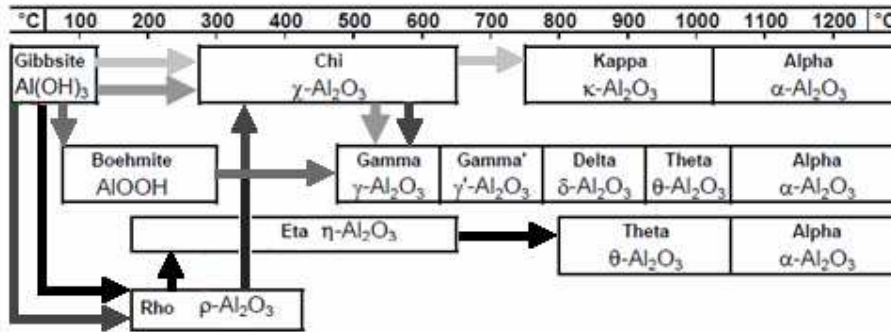

Figure 1. The decomposition pathways of gibbsite [3]

The formation of boehmite is the result of the hydrothermal processes within the particle. The conditions causing higher internal steam pressure within the particle (big particles, fast heating) favour the second pathway. While the heating is slow, small particles undergo direct decomposition into oxides [4].

Above statements are valid in case of calcination at normal atmospheric pressure, while in case of vacuum or overpressure the decomposition processes are different [5]. According to experience both of the pathways exist when gibbsite from the industrial Bayer process is calcined. Wittmann et al. argued that the mass loss during the gibbsite-boehmite and the gibbsite-oxide conversion (up to 450 °C) is 28% while during the decomposition of the formed boehmite is 6.5%. Therefore the water molar ratio of the material, consisting of aluminum oxide and boehmite, became 0.57 after the gibbsite has been completely decomposed [6].

Long term grinding causes the transformation of the gibbsite into amorphous phases; the forming of gel-like hydroxides retains the initial water content of gibbsite. The dehydration of gel-like hydroxides begins at lower temperature and comprises a broader temperature interval compared to the dehydroxylation of gibbsite. The products of the dehydration of the gel-like hydroxides are amorphous oxides. The amorphous oxides transform at elevated temperatures into crystalline transitional oxides and further into corundum.

MacKenzie et al. argued that dehydration of gibbsite, if ground for 20 hours, is endothermic and occurs in two steps. At the temperatures 820 °C and 990 °C the endothermic reactions of formation of the crystalline phases are perceptible [7]. Koga reported that bayerite [ $\beta$ -Al(OH)<sub>3</sub>], ground 30 hours, decomposes similarly. Grinding transforms the material into amorphous state; the thermal decomposition begins at lower temperature and occurs in a wider temperature range. The formed oxides are converted into crystalline form at 800 °C during exothermic reactions [8, 9].

Genc investigated the thermal conversion of ultrasonic treated boehmite samples. The decomposition of treated samples began at lower temperature [10]. The research results of thermal conversion of long term ground materials are utilizable in the ceramic industry [11]. The aim of our experiments was to find a short term grinding method, while the original mineral composition is kept unchanged, where the contribution of the pathway of thermal decomposition via boehmite declines. That gives us the possibility of avoiding the intruder effect of gibbsite-boehmite transformation in case of thermoanalytical investigation of samples containing mixture of aluminum-oxides-hydroxides and oxi-hydroxides.

## 1. Materials and experimental methods

### 1.1. Mechanical grinding

The particle size distribution of the sample obtained from the bayer process is shown in 0. The aluminum hydroxide content of the sample is above 99.5% while the loss of ignition 34.5% is corresponding to the stoichiometric values. The samples were ground at a rotation speed of 500 rpm in an agate jar of 250 ml together with six agate balls of 18 mm in diameter. We used a Fritsch Pulverisette 6 planetary mill for different durations of grinding. The amounts of samples measured into the grinding jar were 24 or 6 g. The variable conditions of grinding are shown in Table 1. In cases of grinding times above five minutes we stopped the mill to scrape the material from the balls and the jar. The particle size distributions are shown in 0 and 4. The investigation of particle size was carried out in the presence of a sodium pyrophosphate solution and the samples were treated with ultrasound for one minute before the measurement.

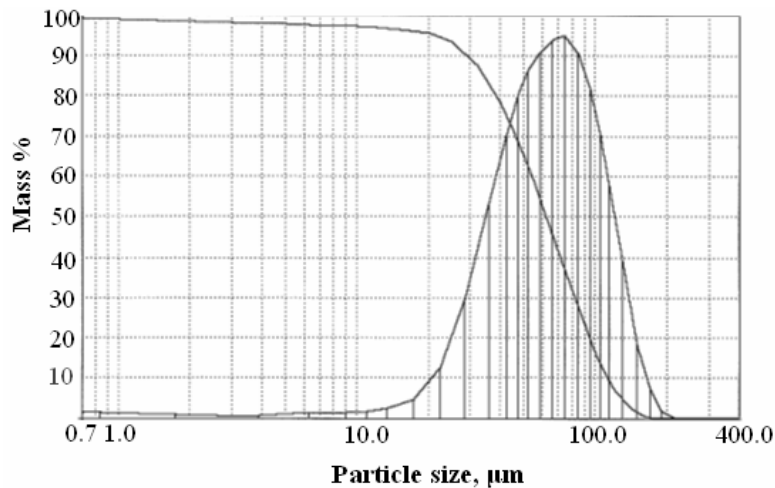

Figure 2. Particle size distribution of the original sample

*Table 1*

*The masses and grinding times of the different ground samples*

<b>Sample number</b>	<b>1</b>	<b>2</b>	<b>3</b>	<b>4</b>	<b>5</b>
Ground sample mass, g	24	24	24	6	6
Grinding time, min	1	5	10	10	15

The particle size of the sample that was ground for one minute doesn't show significant differences compared to the original unground sample, whereas in the case of samples 3 to 5 the particle size decreased by one order of magnitude. The duration of grinding is the same in the case of samples 3 and 4, only the amounts poured into the grinding jar differ. It is observable that the effect of the amount of ground material on the formed particle size is not significant. The finest sample is the aluminum hydroxide ground 15 minutes long.

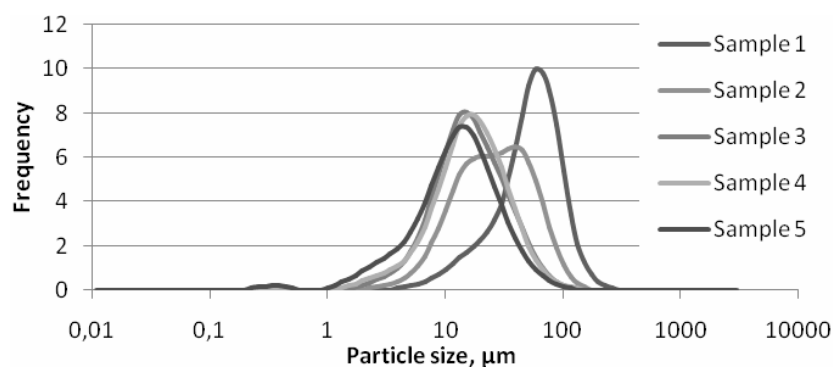

*Figure 3. The particle size distribution of the ground samples*

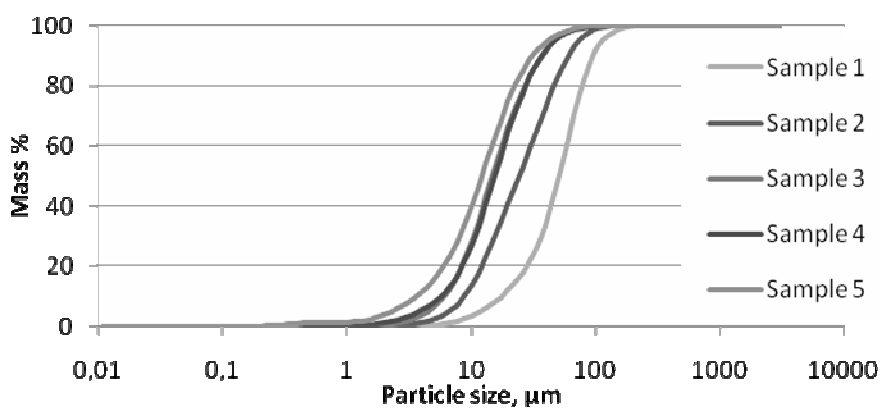

*Figure 4. The cumulative particle size distribution of the ground samples*

### 1.2. Heat treatment in furnace

Thermal behavior of gibbsite is known to display differences for natural and synthetic materials. An endothermic reaction at ~260 °C is characteristic for synthetic gibbsites [12]. One of our goals in our investigations was to observe the material which occurs during endothermic reaction. Thus, combined X-ray diffraction, heat treatment in furnace and thermal analytical experiments were performed.

The material was investigated in raw and ball-milled for 15 min (sample 5) states. All samples were spiked with zincite (ZnO) as internal standard (16.6wt%) and homogenized in an agate mortar, then heated in laboratory furnace (Nabertherm, with  $\pm 5$  °C thermal inertia) at 260 °C for 30 minutes to simulate the reaction observed by DTA.

### 1.3. Measurements

TA measurements were performed on a MOM Derivatograph-C PC controlled thermal analysis system and Setaram Setsys 24 controlled by Setsoft 2000, by simultaneous thermogravimetry (TG), derivative thermogravimetry (DTG) and differential thermal analysis (DTA). A reference material of  $\alpha$ -Al<sub>2</sub>O<sub>3</sub> was used, in similar volume as the measured samples. Evaluation of the results obtained by the MOM Derivatograph was done with the MOM Winder software. The base-line correction of DTA curves was done with measured correction data and polynomial smoothing was applied to remove static noise from the curves. The used heating rates were 10 K min<sup>-1</sup> [13–15].

XRD measurements were performed on a Bruker D8 Advance diffractometer equipped with a Cu-K $\alpha$  source (40kV, 40mA), a primary Göbel-mirror with 2.5° axial-Soller and 0.6mm exit slits and Grazing Incidence Soller with point detector. Data processing was carried out in DiffracPlus EVA, data was prepared for Search/Match by K $\alpha$ <sub>2</sub>-subtraction (Rachinger), Fourier-polynomial filtering and polynomial background subtraction. Search/Match was run on ICDD PDF2(2005). Quantification of results was made through Rietveld-refinement in TOPAS3, using FPA (Fundamental Parameters Approach) convolution for instrumental contribution. Crystal structure information was retrieved from Crystallography Open Database (COD), preferred orientation (PO) was corrected by the March-Dollase method. Powder specimens were prepared in agate mortar by manual grinding to avoid dehydration.

## 2. Experimental results and discussion

### 2.1. TG-DTA

The thermal decomposition of the aluminum hydroxides takes place in more steps. All of them are endothermic reactions. The first step is the gibbsite-boehmite transformation in the temperature range of 220–270 °C. The next step is the decomposition of residual gibbsite into oxides between 270 and 390 °C. The third step is the decomposition of boehmite above 480 °C. The final TG weight loss taken from 220 °C to 1000 °C is 34.4%, which corresponds to the stoichiometric values.

The TG-DTG and DTA curves of the unground and ground and not heat treated samples are shown at the 0 and 6. It is visible, that grinding decreased the magnitude of the

decomposition pathway via boehmite. The loss of mass above the temperature 450 °C decreases increasing the grinding time: the mass loss of the unground sample above 450 °C is 5.88%, while in case of Sample 5 it is 4.40%. The corresponding molar ratio changes are 0.35 and 0.26 respectively.

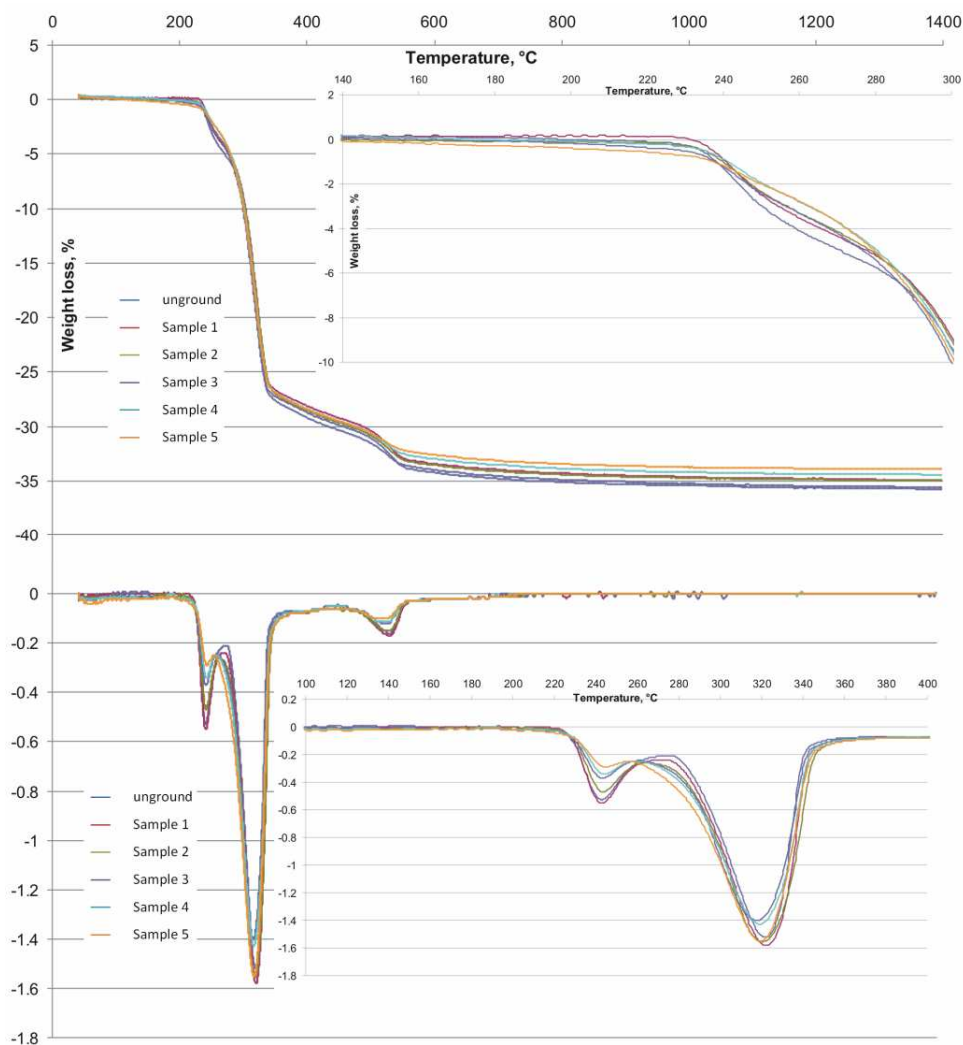

Figure 5. TG and DTG curves of the unground or ground and previously not heat treated aluminum hydroxide samples, in the function of temperature.  
Above: TG, %; below: DTG, mg/min

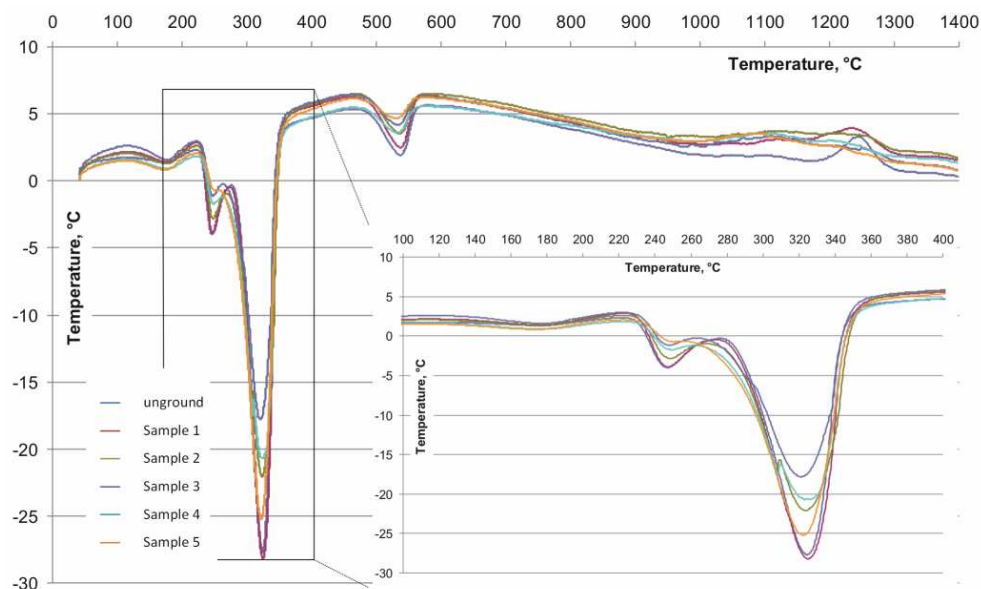

Figure 6. DTA curves of the unground or ground and previously not heat treated aluminum hydroxide samples, heat effects in the function of temperature

The heat treatment at 260 °C was carried out on the unground and 15 min ground (Sample 5) samples. The thermal curves of the heat treated samples are shown on the 0. The presence of boehmite formed by the heat treatment is more accentuated in the unground sample. In spite the fact that heat treatment was carried out at 260 °C, the weight loss begins below 100 °C. The possible explanations are given in the following sections.

## 2.2. X-Ray powder diffraction

Rietveld-refinement on unheated and heated samples enabled us to determine the amorphous content by the internal standard method. However, PO severely affected the refinement in the non milled sample, due to the sub-micrometric platy crystallites. Both samples were found to contain some amorphous material, although TG showed that weight loss almost equals the H<sub>2</sub>O content of the 100% crystalline gibbsite material (Table 2). The results show that grinding increased the amorphous content of the sample, whereas the boehmite content after heat treatment is almost three times reduced in the ground material compared to the unground.

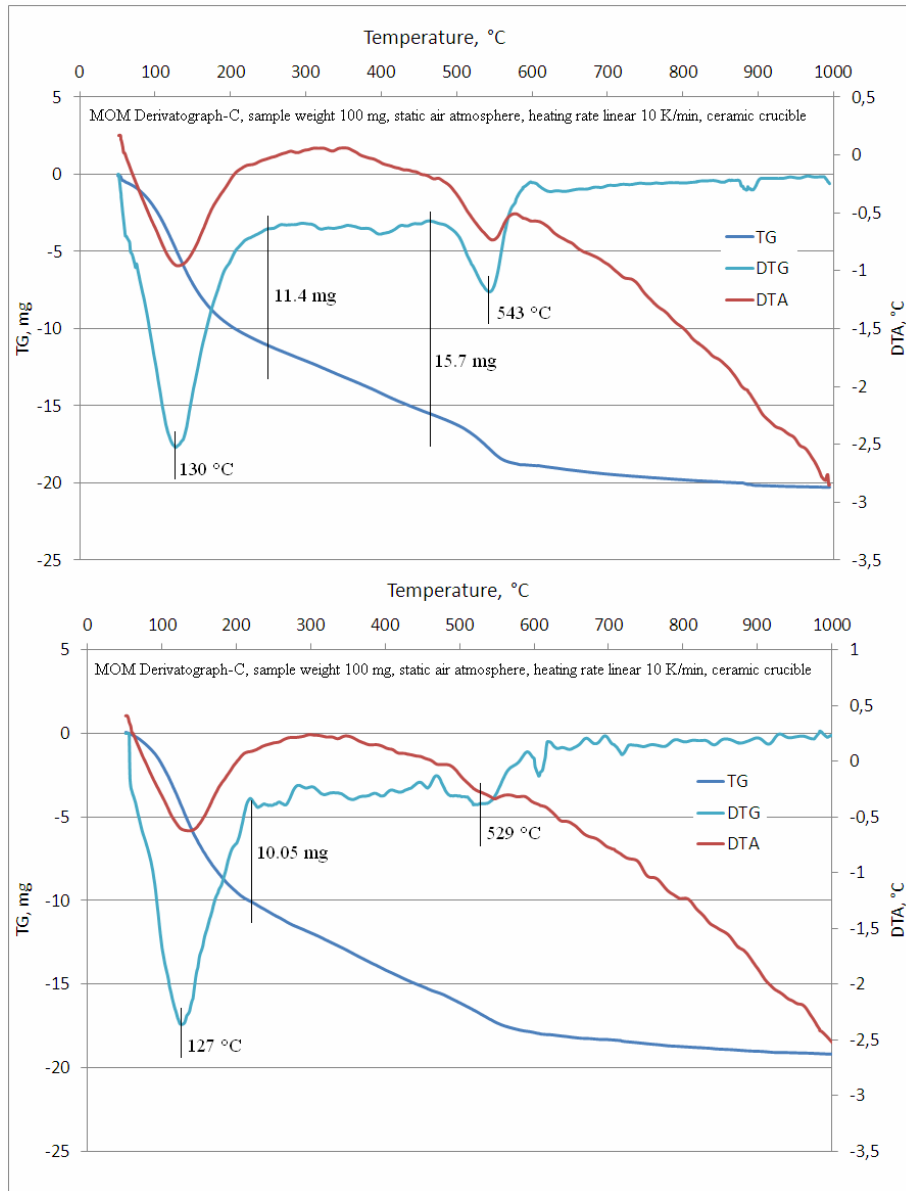

Figure 7. TG, DTG, DTA curves of the heat treated aluminum hydroxide samples, heat effects and mass loss in the function of temperature, above: unground sample, below: 15 min ground sample



Table 2  
The composition (Rietveld-refinement, XRD)  
of the samples heated and unheated

Phases	Unheated		Heated at 260 °C	
	Unground	Ground for 15 min	Unground	Ground for 15 min
Gibbsite	89,646	74,817		
Boehmite			15,282	6,636
Amorphous	10,354	25,183	84,718	93,364

The role of heating was to observe whether intermediate hydrous compounds develop during this reaction or direct boehmite formation is going on. Weight losses of ~13% for ground aluminum hydroxide and ~16% for the unground sample were recorded. The second XRD investigation revealed that gibbsite has decomposed from both samples and boehmite together with an undetermined compound has formed. The undetermined compound is observed as one single broad peak, resembling the gibbsite (002) shifted to lower  $d(\text{\AA})$  value. This could indicate that a gibbsite pseudo-hydrate has formed, but without detailed spectroscopic and crystallographic characterization it is not possible to conclude on its nature. In Rietveld-refinement this undetermined product was considered as part of the amorphous content (Figure 8 and 9).

However, TA analysis performed on material dehydrated at 260 °C taken in a few days revealed that rehydration occurred, since the endothermic peak associated with weight loss starting at the beginning of the analysis cannot be interpreted by other processes. XRD taken on heated materials after several days did not evidence any gibbsite or newly crystallized hydrated compound. Thus, the phenomenon is explained by H<sub>2</sub>O shell formation around crystalline AlOH and amorphous AlOH or Al<sub>2</sub>O<sub>3</sub>.

To find out what is the approximate composition of the amorphous component(s) quantified by Rietveld-refinement, TA and heating in furnace was completed also with the drying experiment. Samples of unground and milled aluminum hydroxides were long-term dried at 60 °C. After 3 hours, a weight loss of 3.2% for milled and 1.8% for unground material was registered, and these values were preserved during the 3 days drying at constant temperature.

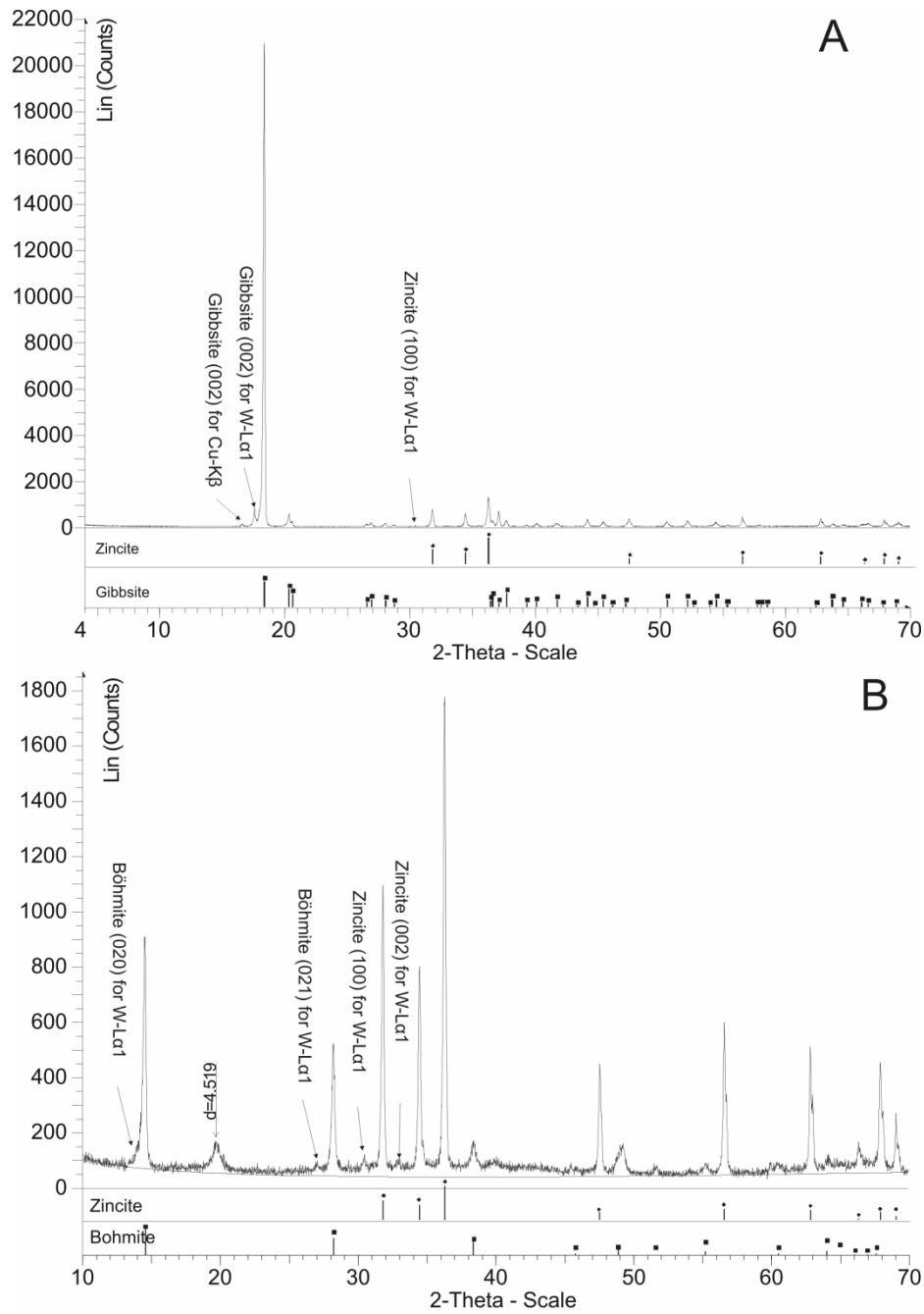

Figure 8. XRD patterns of the unground samples; A: unheated; B: heated

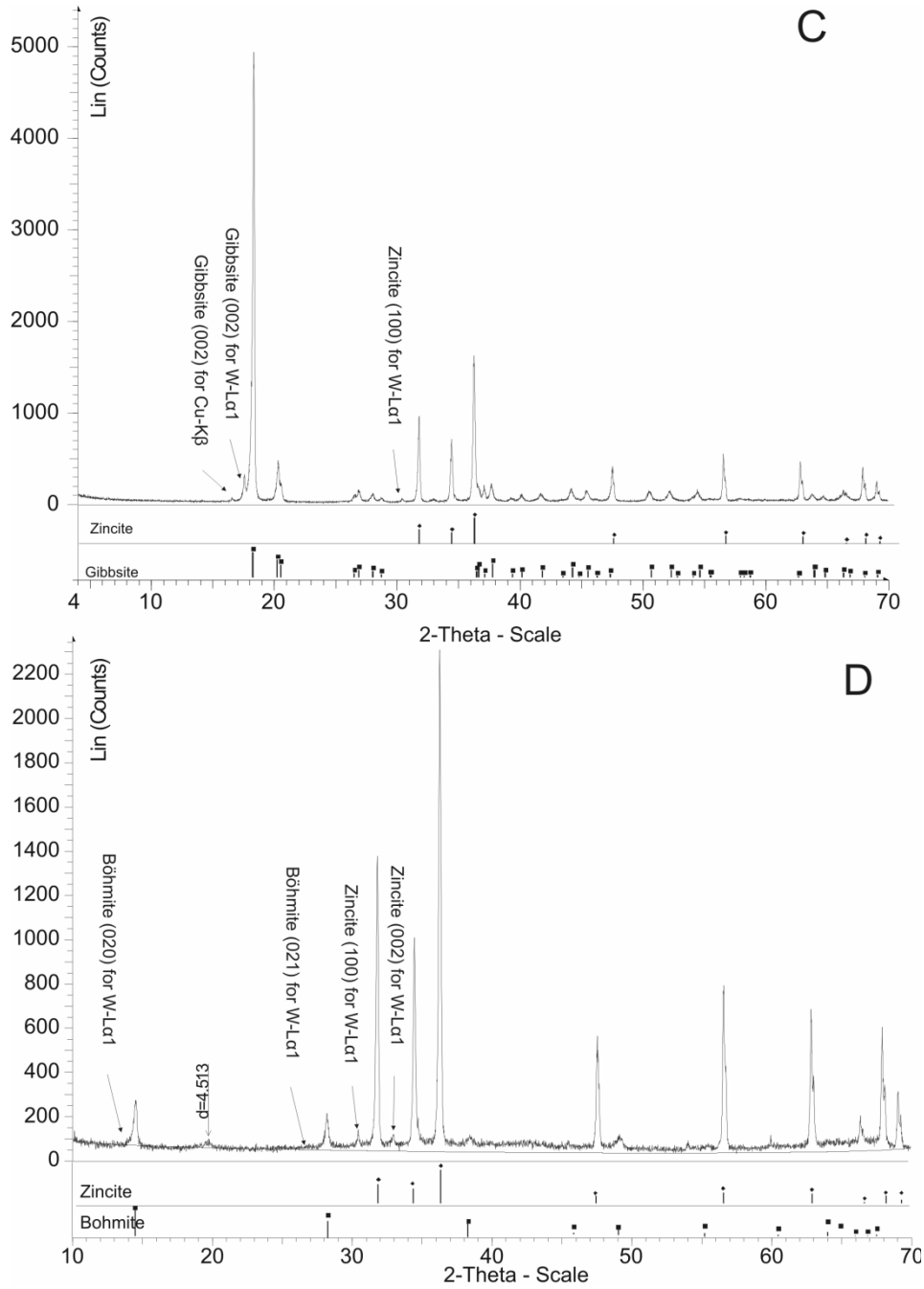

Figure 9. XRD patterns of the ground samples; C: unheated; D: heated

## Conclusions

Summarizing our results, we conclude that the original aluminum-hydroxide material contains at least two types of amorphous materials: H<sub>2</sub>O as fluid inclusion in gibbsite crystals and amorphous Al-compound with superficially bound H<sub>2</sub>O.

The Rietveld-refinement for unground material indicated ~10% amorphous content, while the dehydration based on TG indicated 95% gibbsite. By drying experiment, H<sub>2</sub>O content of ~2% was found to be evaporated <80 °C where TA is unreliable.

The grinding of the material increased the amorphous content of the aluminum hydroxide, whereas the significance of the thermal conversion pathway via boehmite decreased.

## Acknowledgments

*The work described was carried out as part of the TÁMOP-4.2.1.B-10/2/KONV-2010-0001 project in the framework of the New Hungarian Development Plan.*

## References

- [1] Gitzen, Walter H.: *Alumina as a Ceramic Material*. Westerville: The American Ceramic Society
- [2] Mercury, H. M. R. et al.: *On the Decomposition of Synthetic Gibbsite Studied by Neutron Thermodiffraction*. 2006., Journal of the American Ceramic Society, pp. 3728–3733.
- [3] Perander, Linus Michael.: *Evolution of Nano- and Microstructure During the Calcination of Bayer Gibbsite to Produce Alumina*. Auckland: The University of Auckland, 2010. PhD dolgozat.
- [4] Gan, Bee K, Madsenb, Ian C.–Hockridge, James G.: *In situ X-ray diffraction of the transformation of gibbsite to  $\alpha$ -alumina through calcination: effect of particle size and heating rate*. Journal of Applied Crystallography: ismeretlen szerző, 2009., 42. kötet, pp. 697–705.
- [5] Rouquerol, J.–Ganteaume, M.: *Thermolysis under vacuum: Essential influence of the residual pressure on thermoanalytical curves and the reaction products*. 1977., Journal of Thermal Analysis, pp. 201–210.
- [6] Wittmann, Zs. et al.: *Phase Composition Analysis of Hydrous Aluminium Oxides by Thermal Analysis and Infrared Spectrometry*. 1992., Talanta, pp. 1583–1586.
- [7] MacKenzie, K. J. D.–Temuujin, J.–Okada, K.: *Thermal decomposition of mechanically activated gibbsite*. 1999., Thermochimica Acta, pp. 103–108.
- [8] Koga, N.: *A comparative study of the effects of decomposition rate control and mechanical grinding on the thermal decomposition of aluminum hydroxide*. 2005., Journal of Thermal Analysis and Calorimetry, pp. 595–601.
- [9] Koga, N.–Fukagawa, T.–Tanaka, H.: *Preparation and Thermal Decomposition of Synthetic Bayerite*. 2001., Journal of Thermal Analysis and Calorimetry, pp. 965–972.
- [10] Genc, Gözde.: *Processing and Characterization of Nanocrystalline Materials*. Izmir, Turkey: Izmir Institute of Technology, 2004.
- [11] Jadambaa, Temuujin: *Mechanochemical Treatment of Solid Mixtures – a Promising Way of Synthesizing Ceramic Precursors*. Химия в интересах устойчивого развития, 2001., pp. 589–595.

- 
- [12] Földvári, M.: *Handbook of thermogravimetric system of minerals and its use in geological practice*. Budapest, Magyar Állami Földtani Intézet, 2011.
  - [13] Arnold, M. et al.: *The Derivatograph-PC – A New Type of Personal Computer-controlled Derivatograph*. 1990., *Journal of Thermal Analysis*, pp. 2693–2699.
  - [14] Arnold, M. et al.: *The Derivatograph-C – A Microcomputer-controlled Simultaneous TG, DTG, DTA, TD and EGA Apparatus. Part II. A Simple Method of Estimating Parameters*. 1987., *Journal of Thermal Analysis*, pp. 679–683.
  - [15] Gruin, I.–Sas, A.: *Application of the Q-Derivatograph for Evaluation of the Melting Enthalpies of Low-melting Compounds*. 1985., *Journal of Thermal Analysis*, pp. 803–811.

